

Article number: 2310308825ESD

Description: E+G Antistatic base for levelling elements  
LV.A-80-24-AS-M24x98-ESD-C

## Measures

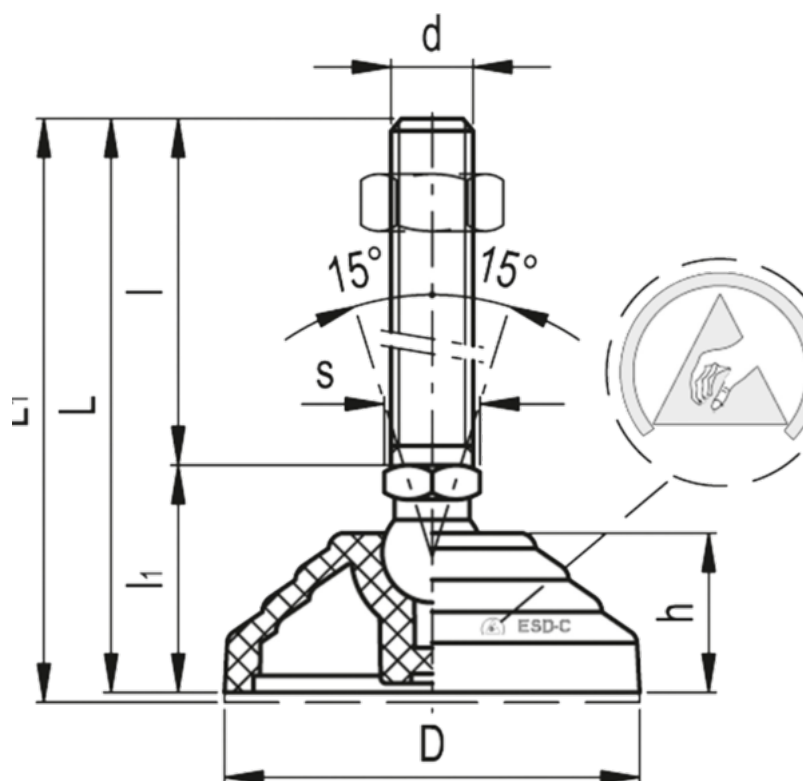

Articulation	= 24	Max load	= 18000
D	= 80	s	= 24
d	= M24	Weight in (g)	= 470
h	= 24		
l	= 98		
l1	= 43		
L	= 141		
L1	= 144		